







**2001 RB**

OWNER'S MANUAL

## Table Of Contents

|                                   |       |
|-----------------------------------|-------|
| Introduction.....                 | 3     |
| Safety Information.....           | 4     |
| Quick Start.....                  | 5     |
| Settings & Sounds.....            | 6     |
| Sound Tips.....                   | 7     |
| Bridged Mode Operation.....       | 8     |
| Bi-Amp and Normal Operation.....  | 9     |
| Installation and Maintenance..... | 10    |
| Front Panel Controls.....         | 11    |
| Rear Panel Controls.....          | 12    |
| Tech Talk.....                    | 13-14 |
| Specifications.....               | 15    |

Please read the Safety Information section on page 4 before continuing.

|  |   |  |
|--|---|--|
|   | <b>CAUTION</b><br>RISK OF ELECTRIC SHOCK<br>DO NOT OPEN   |   |
| <b>CAUTION:</b> TO REDUCE THE RISK OF ELECTRIC SHOCK, DO NOT REMOVE TOP COVER. NO USER-SERVICEABLE PARTS INSIDE. REFER SERVICING TO QUALIFIED SERVICE PERSONNEL. |   |  |
|   | The lightning flash with arrow head symbol within the equilateral triangle is intended to alert the user to the presence of uninsulated 'dangerous voltage' within the product enclosure that may be of sufficient magnitude to constitute a risk of electric shock to persons. |   |
|  |   | The exclamation point within an equilateral triangle is intended to alert the user to the presence of important operating and maintenance (servicing) instructions in the literature accompanying the appliance. |
| <b>WARNING!</b> TO REDUCE THE RISK OF FIRE OR ELECTRIC SHOCK, DO NOT EXPOSE THIS APPLIANCE TO RAIN OR MOISTURE   |   |  |
| CAUTION: TO PREVENT ELECTRIC SHOCK, MATCH WIDE BLADE OF PLUG TO WIDE SLOT, FULLY INSERTED.   |   |  |
| ATTENTION: POUR EVITER LES CHOCS ELECTRIQUES, INTRODUIRE LA LAME LA PLUS LARGE DE LA FICHE DANS LA BORNE CORRESPONDANTE DE LA PRISE ET POUSSER JUSQU'AU FOND.    |   |  |

**Gallien-Krueger**  
 2234 Industrial Dr. Stockton, CA, 95206  
 phone: 209-234-7300  
 fax: 209-234-8420  
 www.gallien.com

*\*All Features and specifications are subject to change without notice*

**Congratulations!**

Your purchase of a new Gallien-Krueger 2001RB amplifier is surely the result of much careful consideration on your part. For our part, we at Gallien-Krueger are pleased that you chose us, and are determined that you will be a satisfied customer. In choosing a 2001RB amplifier, you now own an amplifier with many unique features which will allow you to create your own distinct sound.

To get the most out of your new purchase, please take a few minutes to read through this manual. If you are in a hurry, we suggest you at least read through the Quick Start and Safety sections before setting up your new rig. This will help get you started and give you a few quick tips, but is not a substitute for reading the entire manual.

Your amplifier should have come with the following items, please check the contents of the box to ensure that you have everything.

Included with your 2001RB amp:

|                                  |          |
|----------------------------------|----------|
| <b>Power cord</b>                | <b>1</b> |
| <b>RFB-III footswitch</b>        | <b>1</b> |
| <b>5 pin DIN cable</b>           | <b>1</b> |
| <b>3.5 MM Mono Cable</b>         | <b>1</b> |
| <b>Owner's manual</b>            | <b>1</b> |
| <b>Warranty card (U.S. only)</b> | <b>1</b> |

If your 2001RB amplifier did not come with all the items listed, or if you encounter problems while setting up your new equipment, please contact your local dealer or GK as soon as possible.

**Gallien-Krueger, Inc.**  
**2234 Industrial Drive**  
**Stockton, CA 95206**  
**phone: (209) 234-7300**  
**fax: (209) 234-8420**  
**www.gallien.com**  
**email: info@gallien.com**

We wish you a lifetime of good playing and remember to always have fun!

**GK Philosophy**

I have never seen the point in doing things the way others have done them. I also have not been very interested in following the latest fad. I'm a Stanford educated engineer who worked my way through school as a musician. Like all musicians, I have lugged amplifiers up stairways and into car trunks, always wondering why these things had to be so heavy, bulky and hard to handle.

As the principal innovator at GK, our products reflect my attitudes and life experiences. I don't model my designs after other manufacturers' products. Instead, I believe new and old problems are best solved with new solutions. Having taken our own path, GK products enjoy a unique, unmatched sound, allowing you every opportunity to make an original statement.

Having supported my products for over forty years, I have learned from the story they tell. Gallien-Krueger is a reflection of that story, and has a commitment to support that legacy. Just as the products I created over forty years ago are still telling their story, the products we create today will be talking to us tomorrow.

We'll be listening,

**Robert Gallien**  
**Founder and President**

## Safety Information

**Verify Line Voltage and Amperage Before Use:** Your amplifier has been factory configured for use with the specific line voltage for your location only. For example, units set to operate within countries that supply 100-120 volt electrical service are not compatible with 230-240 volt systems used in other countries!

**120 Volt/60Hz 15 amp circuit for the USA and Canada.**

**230 Volt/(50/60Hz) 10 amp circuit for the UK and Australia.**

**230 Volt/(50/60Hz) 10 amp circuit for Europe.**

**100 Volt/50Hz 15 amp circuit for Japan.**

**220 Volt/50Hz 10 amp circuit for Korea.**

**Proper AC circuit for all other countries.**

Connecting the amplifier to a line with specifications other than indicated above can create a safety and fire hazard, and may damage the amplifier. If you have any questions about the voltage requirements for your specific model, or about the line voltage in your area, contact your dealer before plugging the unit into a wall outlet.

**Verify AC Circuit Capacity Before Use:** The high power output of your amplifier may require heavy current draw under full load conditions. To insure proper performance and avoid potential safety hazards, we recommend connection to line circuits with amperage specified as above. Connecting multiple amplifiers to the same circuit, or connecting the amplifier to the same circuit used by other heavy power devices, such as high wattage lights, may cause circuit breakers to trip. It is always a good idea to avoid using any audio equipment on the same AC circuit as equipment with motors, such as air conditioners or refrigerators. This will lessen the possibility of power variation and electrical start up noise affecting your sound.

**Warning:** Do not disconnect or plug in the instrument or the speaker cable with the amplifier power on. Be sure the amplifier unit is turned off before connecting to speakers.

**Do Not Use Extension Cords:** To avoid safety hazards, use only the power cord supplied with your unit. If a replacement cord is used, make certain that it is of consistent quality and gauge as the original. We do not recommend using extension cords with this product. As with all electrical devices, do not run power cords under rugs or carpets or place heavy objects on them. Damaged power cords should be replaced immediately with cords meeting factory specifications.

**Mains Disconnect:** To isolate the unit from the AC mains, disconnect the power cord from the unit and the AC outlet. When disconnecting the power cord from an AC outlet, always pull the plug, never pull the cord. If you do not intend to use the amplifier for a considerable length of time, disconnect the plug from the AC outlet.

**Do Not Open The Amplifier Enclosure:** There are no user serviceable components inside this product. Opening the amplifier enclosure may present a shock hazard, and modification to the product will void your warranty. If liquid enters the unit, or any metal object such as a paper clip, wire, or staple accidentally falls inside the enclosure, disconnect the unit from the AC power source immediately and consult an authorized service station.

**Unpacking:** The carton and packing materials used in shipping your new amplifier were specially designed to cushion it from the shocks and vibration that occur during transport. We suggest that you save the carton and packing materials for use in shipping, in the event you move, or if the amplifier needs repair.

**Maximum Recommended Loads:** Two 4 Ohm or four 8 Ohm cabinets per side, dual mono mode. One 4 Ohm or two 8 Ohm cabinets in bridged mode. One or two 8 Ohm horns on the 50W Amps.

## Quick Start

The 2001RB is designed to be simple to operate. All controls have a well defined purpose and are well behaved. These directions will take you through the basics and give you a good start for setting up your sound.

**Plug it in:** Set the power switch to Off and connect the supplied power cord, from the amplifier AC receptacle, to an AC power outlet of proper voltage and power rating (see safety information on page 4 for details).

**Connect your cabinets:** Connect your speaker cabinet(s) to the LEFT or RIGHT ¼" speaker jacks or Speakon outputs if using our RBH series cabinets. Be sure not to exceed the maximum recommended speaker loads below.

**Maximum recommended speaker loads:** Two 4 ohm or four 8 ohm cabinets per side in dual mono mode. One or two 8 ohm horns per side on the 50W amp. To connect other manufacturer's cabinets, use the LEFT or RIGHT ¼" jack speaker outputs only.

If you are using an RBH Series cabinet, use a 4 conductor Speakon cable to connect to the Speakon outputs on the rear panel of the amplifier. In addition, set the switch on the RBH cabinet to biamp.

For more information on bridged mode and biamped mode, see pages 8-9.

**Caution:** Do not connect the Speakon cables labeled 'Bridge Mode' to the 2001RB. This may result in damage to the amplifier.

When using non GK cabinets that have Speakon connectors, only use a standard two wire Speakon cable. A four conductor Speakon style connector could result in damage to your amplifier.

**Initial front panel control settings:** Set all EQ controls and the Boost control to 12 o'clock. The Voicing Filters should be turned all the way down to get a flat response. Set the Level and Master Volumes at 0. If you have a five string bass, push the button marked String Bass in. Make sure the Level A/B button is out, so you are in the clean channel.

**Plug in your bass:** Using an instrument cable, connect your bass to the Input jack and press the power switch on. If you have active tone controls on your bass, turn all of the controls to the middle or flat position and turn the volume all the way up. If you have conventional, passive tone controls, turn all tone and volume controls all the way up.

**Level and Master Volume settings:** Set the Master Volume to 12 o'clock. Turn the Level-A volume up as you play. Try not to turn it past 1 o'clock if you have a bass with active tone controls unless you want an overdrive effect. If the yellow clip light turns on, press the -10db button in. If it is still on, try turning the volume down on your bass.

At this point you should be hearing your bass quite well. You can use the Volume and Woofer Master to achieve a comfortable sound level. Remember, If you need more volume, turn up the Woofer Master control first.

# 2001RB

## Settings and Sounds: 2001RB

The 2001RB is versatile in its sound and tone. Below are a few suggested amp settings that can be used as starting points to define your own sound.

**Note:** the Gain/Overdrive settings will vary according to the output of your bass.

**Contour note:** At higher playing levels the contour should be set lower for mid range clarity. To get 800RB voicing, the contour should be set to 0 or 10 only.

**Volume note:** Adjust volume before playing these recommended settings.

### Tube Style Grunge: Both pickups recommended

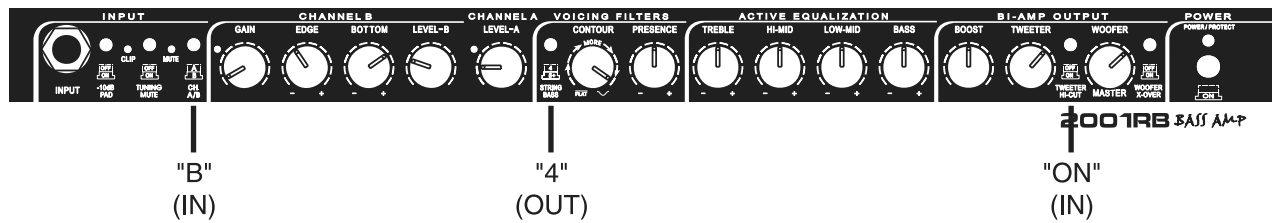

### Insane Gain: Back pickup recommended

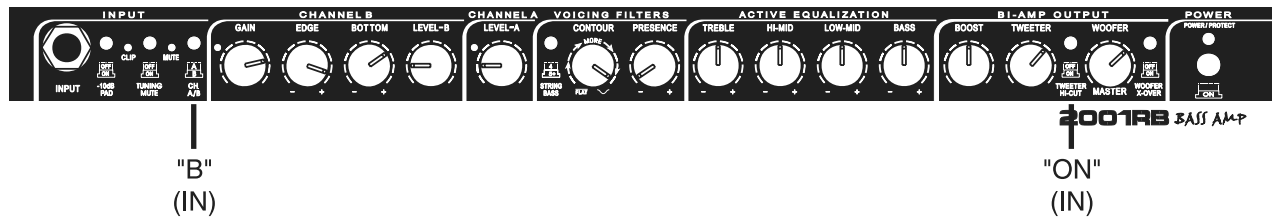

### Deep Bass: Front pickup recommended

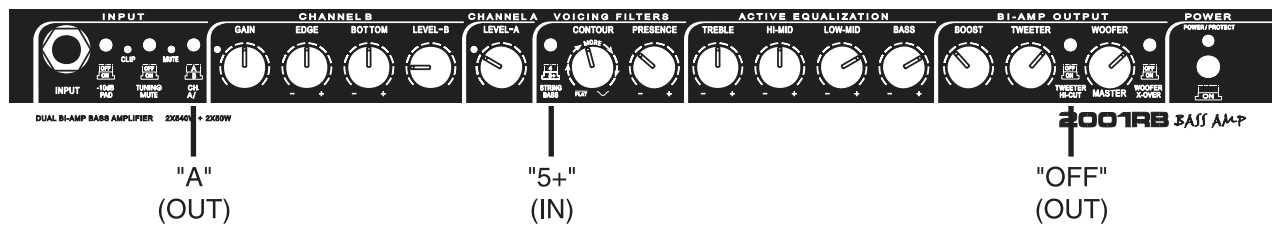

### Slap: Both pickups recommended



## Sound Tips

The 2001RB has several unique features which if used properly, will obtain that sound that's in the back of your head.

**The Equalizer:** The Equalizer is used to fine tune your sound. When adjusting it, do it just a little at a time. These are active circuits, and small changes can make a big difference in your sound. With a little experimentation you will find that this equalizer is very easy to use, never sounds weird and provides you with a large variety of great sounds, unique to GK.

**Contour:** Increasing the Contour level will scoop out mid-range frequencies while boosting the highs and lows. The sound, once again, is unique to GK and unavailable on any other bass amp. Lower contour settings are recommended for midrange clarity at higher playing levels. For the classic 800RB voicing, set the contour control either on 0 or 10 (Off, On on 800RB).

**String Bass:** The way a Bass amp deals with the instrument low string is a critical part of its sound. In fact, a five string instrument requires an entirely different low end response than a four string instrument. No equalizer can make the necessary adjustments to accommodate both. However, the String Bass button on the 2001RB does just that. When it is out, the 2001RB is voiced like the 800RB. Push it in and the 2001RB is voiced for five string instruments. For some playing styles you may want it in, even with a four string instrument.

**Boost/Master:** Turning up the Boost control, will add a little growl to your tone. This is an unmistakable GK trade mark sound, that you will grow to appreciate. Raising the Boost while lowering the Master will add more growl while keeping the sound level the same. Growl is actually a small amount of even order harmonic distortion, that sounds great through a woofer, but horrible through a horn (see biamp solution below). For most playing situations, the Master is set between 12 & 3 o'clock. The cleanest sound is obtained by setting the Master above 12 o'clock, and going above 3 o'clock for maximum power situations.

**Direct Out:** The 2001RB provides a low noise, high quality balanced direct out for connection to PA and recording consoles. With the Pre/Post EQ switch set to "Pre" (Out), the direct output signal is fed directly from our low noise, high headroom, FET input stage providing a low noise output superior to external direct boxes and impedance transformers. In addition, this output is calibrated for 1.0V (0 dBV) output and can be adjusted to unity gain (instrument level) by adjusting the Level control to -15 dB (U). With the switch in the Pre position, the Direct Output signal is only effected by the Level, -10dB Pad, and Tuning Mute controls. This allows you to adjust your tone and volume on stage without changing the Direct Output signal level and confusing your sound man.

Changing the Pre/Post EQ switch to "Post" (In), sends the "GK sound" and preamp response to the Direct Out jack. This gives you complete control over the Direct Out's tone and volume. In addition, a Ground (Gnd) Lift switch is included to remove hum and buzz when connecting to equipment powered by a different ground system.

## Bridged Mode Operation

Note: To operate the 2001RB in bridge mode, you must use the L/BR Speakon outputs only. Using the Left channel, 1/4" outputs will not work, since the ground for those jacks are internally disconnected when in bridge mode. Using any of the Right channel 1/4" or Speakon outputs is not recommended as this will result in a malfunction, or undesired operation of the amplifier.

Make sure nothing is connected to any of the Right channel outputs.

Slide the Bridge Mode switch on the back of the amp from dual mono, to Bridge.

The Right Level knob on the back of the amp should be turned all the way up (clockwise) or power output will be compromised.

Since Bridge Mode operation is only available through the Speakon outputs, the type of Speakon cable you need depends on the brand of cabinets that you are using. When using our RBH or NEO Series cabinets, using our four conductor Speakon to Speakon biamp cable will allow Bridged Mode and biamp operation simultaneously. Since the 50W horn amps are always active, this allows you to deliver 1080W to your cabinet and 50W to the horn. When using other brand name cabinets a two conductor Speakon cable will be needed but the biamp feature will not work. It is very important, that these two conductor Speakon cables are wired correctly. The 1+ pin connects to the tip of the 1/4" plug and the 1- pin connects to the shield.

**DO NOT USE 'BRIDGED MODE' SPEAKON CABLES WITH THIS AMP!**

These are wired 1+ and 2+ which would connect the horn and woofer amps together. This could cause damage to your cabinet and/or the amplifier.

### 2001RB setup for Bridged Bi-Amp Operation:

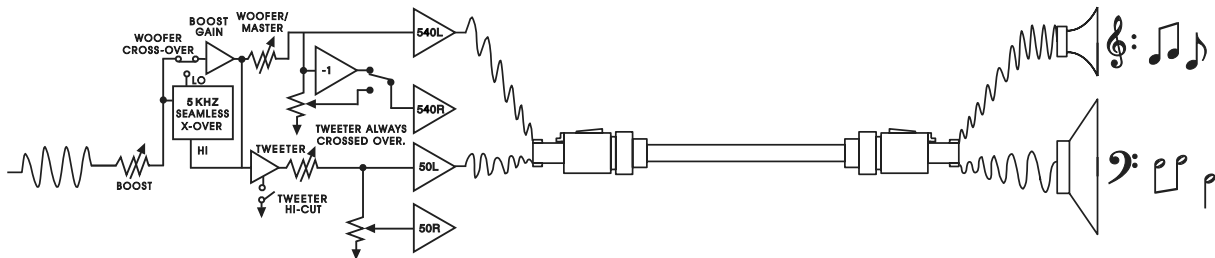

### 2001RB setup for Bridged Normal Operation:

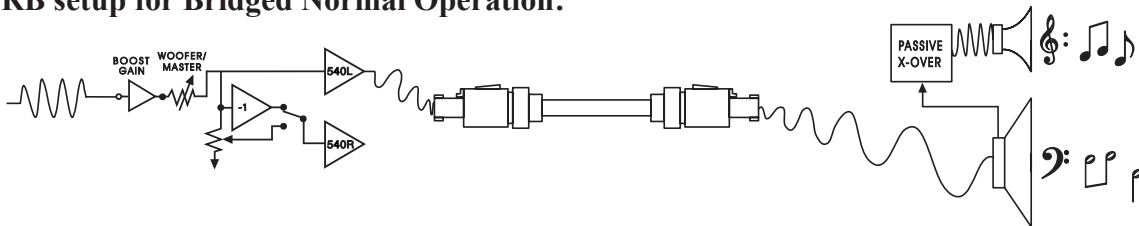



**Bi-Amp and Normal Operation**

The 2001RB's unique design allows for easy setup into biamp or normal configurations. The operational mode is configured by how you connect your speaker cabinets. In addition, you have the option of driving one cabinet in biamp and one with normal operation.

**2001RB setup for Bi-Amp Operation:**

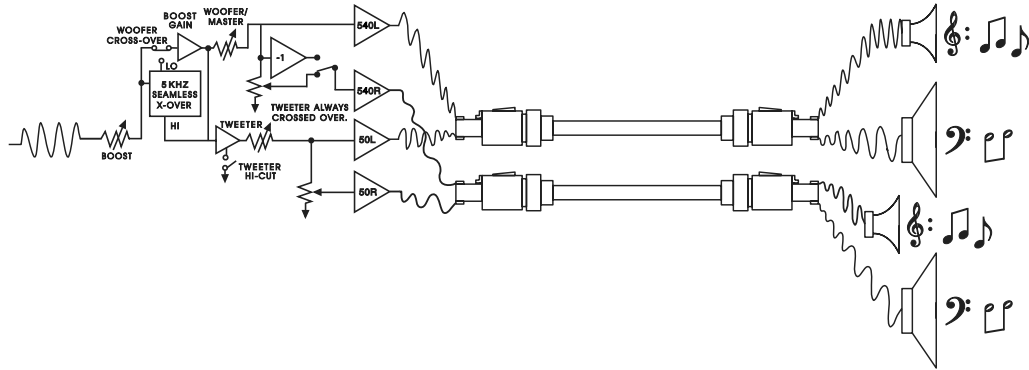

**2001RB setup for Normal Operation:**

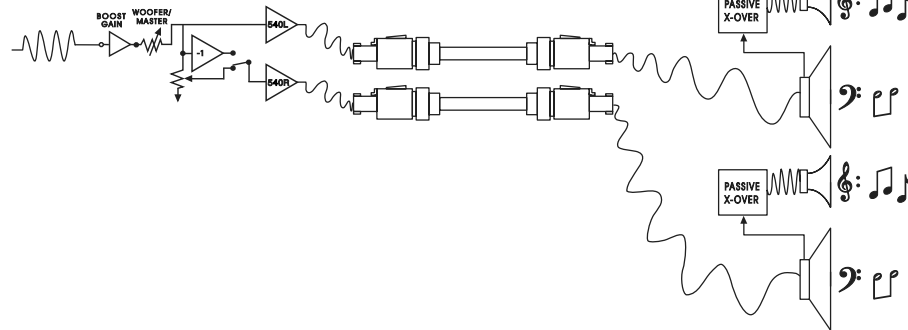

**2001RB setup for Bi-Amp Operation**

The Bi-Amp feature of the 2001RB is automatically engaged when you connect an RBH or NEO series cabinet (with switch on the cabinet set to biamp) to the 2001RB with a 4 conductor Speakon cable. This setup gives the 2001RB complete control of the tweeter and woofer signals sent to your rig. Now you can push the woofers to the max, while the tweeter remains clean, crisp and free of clipping distortion. In addition, a smooth tight tone is easily dialed in by adjusting the Tweeter and Woofer Master controls on the 2001RB front panel. **Note:** In the biamp configuration, we recommend starting with the woofer X-Over and Tweeter Hi-Cut controls in.

**2001RB setup for Normal Operation**

The 2001RB series amplifier is configured for normal operation when you are connecting to any cabinet with a 2 conductor Speakon cable, 1/4" to 1/4" speaker cable or 1/4" to banana plug speaker cable. In this setup, the speaker cabinet is driven by the 540W amp and the 50W tweeter amplifier is not used. If you are using RBH or NEO series cabinets, the volume of the tweeter (relative to the woofer's volume) can be adjusted using the Horn Level control of the cabinet's internal crossover.

- |                         |                                      |
|-------------------------|--------------------------------------|
| <b>GK Speakon Cable</b> | <b>GK RBH or NEO Series Cabinets</b> |
| + 540W Amp +            | Set to biamp mode.                   |
| 1- 540W Amp -           |                                      |
| 2+ 50W Amp +            |                                      |
| 2- 50W Amp -            |                                      |

- |                         |                                      |
|-------------------------|--------------------------------------|
| <b>GK Speakon Cable</b> | <b>GK RBH or NEO Series Cabinets</b> |
| 1+ 540W Amp +           | Set to Full Range mode.              |
| 1- 540W Amp -           | Any brand name cabinet with          |
| 1/4" Speaker Cable      | appropriate impedance and            |
| Tip 540W Amp +          | power rating                         |
| Shield 540W Amp -       |                                      |

## Installation and Maintenance

**Installation:** To insure proper operation and to avoid potential safety hazards, place the unit on a firm, level surface. When installing the unit in a rack, be sure the mounting hardware can support the amplifier's weight. To save space in your rack, the 2001RB's feet can be removed using a Phillips head screwdriver.

**Ventilation:** Make certain that proper space is provided for ventilation. Never block the fan vent holes in the rear or front of the amplifier. If the amplifier will be installed in a rack or other enclosed area, make sure that there is sufficient air movement within the enclosure to allow proper cooling. Consult your dealer for more information.

Avoid installation in extremely hot or cold locations, and areas that are exposed to direct sunlight, or near heating equipment. Avoid moist or humid locations.

Remember, power amplifiers generate heat. The heat sink fins and ventilation slots that form part of the enclosure are specially designed to displace this heat. Placing other electronic equipment near these heat dissipation systems may possibly affect the long term reliability of both your amplifier and the other equipment.

**Moving the Unit:** Before moving the unit, be certain to disconnect any cords and make sure that you disconnect the unit from the AC outlet.

**Cleaning:** When the unit gets dirty, clean only with a dry cloth. Never use benzene, thinner, alcohol, or other volatile cleaning agents. Do not use abrasive cleaners, as they may damage the finish of metal parts. Avoid spraying insecticides near the unit.

**Maintenance:** Your new amplifier is rugged. It was built to give you years of trouble free operation, if it is operated in accordance with the instructions contained in this manual. The only maintenance required is cleaning. If you are going to move your amplifier around frequently, we recommend a road case to protect it from scratches and road wear.

**Speakon Cables:** To make use of the 2001RB's Biamp and Bridge mode features you will need to use a four conductor Speakon cable to connect to a GK RBH or NEO Series cabinet. This specially designed cable carries the signals for both amplifiers (540W Woofer Amps and 50W Tweeter Amps) to the speaker cabinet. Below is a table describing the Speakon cable connections to the 2001RB head.

| Speakon Pin # | Signal            | Wire/Color |
|---------------|-------------------|------------|
| 1+            | 540W Woofer Amp + | White      |
| 1-            | 540W Woofer Amp - | Black      |
| 2+            | 50W Tweeter Amp + | Red        |
| 2-            | 50W Tweeter Amp - | Green      |

To obtain an additional 4 conductor Speakon cable for use with the 2001RB please contact your local dealer or contact GK directly.

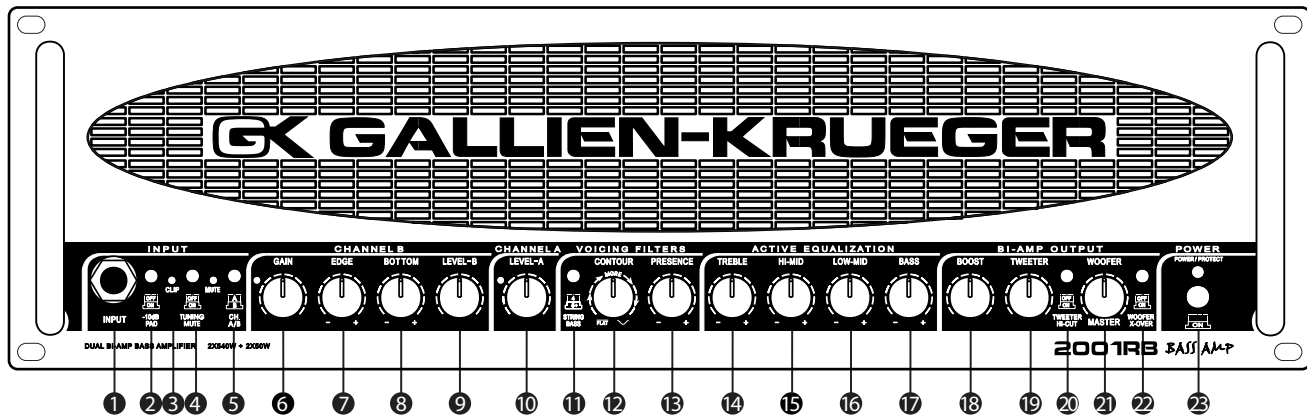

### Front Panel Controls

- ① **Input:** A standard ¼" input jack to plug in active or passive basses using a shielded cord
- ② **-10dB PAD:** Input attenuator button. The button is generally left out, except in cases when the clip LED flashes. This switch should be pressed if the CLIP LED stays on continuously. It may be necessary to pad the input when using a bass with active electronics or very high output
- ③ **Clip:** This LED lights yellow when the input is being overdriven. If -10dB PAD (2) is pressed and clip LED still stays lit, turn down the volume on your bass.
- ④ **Tuning Mute Button:** Set this switch to 'ON' (In) when tuning up. This switch mutes all outputs from the amplifier (speaker, direct, and balanced outs) so you can tune up without sending signal to the audience, speakers, or the P.A. system. Tuning Mute can be footswitch controlled which will leave your hands free to tune your instrument. To control Tuning Mute by footswitch, the 'Tuning Mute' switch on the 2001RB must be in the 'OFF' (OUT) position
- ⑤ **Channel A/B:** Switches between the Normal and Overdrive channels. When in the 'B' (In) position, the switch activates 'Channel B' (Overdrive). 'A' (Out) position activates 'Channel A' (Clean). In order to use the footswitch to control the channel switching, Channel A/B should be in the 'A' (out) position
- ⑥ **Gain:** Controls the amount of overdrive in the 'B' channel. At low settings it provides a smooth distorted sound. At high levels it will provide full saturation with long sustain
- ⑦ **Edge:** Treble control for the Overdrive channel.
- ⑧ **Bottom:** Bass control for the Overdrive channel.
- ⑨ **Level B:** Adjusts the output level of the Overdrive channel
- ⑩ **Level A:** Sets preamp gain after the input stage. It is used in conjunction with the input pad, to optimize the amplifier's headroom
- ⑪ **4/5 String Bass:** Switching this button to the 'ON' position, voices the pre-amp for basses with 'B' tuning (5 string). Leaving it in the 'OUT' position will voice the amp like the 800RB, for a four string bass
- ⑫ **Contour:** Drops the mid-range frequencies while boosting lows & highs
- ⑬ **Presence:** This adds edge and definition to higher frequencies
- ⑭ **Treble:** Boost and cut at 7kHz+14dB shelving type. Add or remove edge and definition
- ⑮ **High Mid:** Boost and cut at 1 kHz +6dB -10dB, 'Q Optimized' band pass type. Works on lower string harmonics, and effects the punch of your sound.
- ⑯ **Low Mid:** Boost and cut at 250Hz +6dB -10dB, 'Q Optimized,' band pass type. This adjusts the main body of your sound
- ⑰ **Bass:** Boost and cut at 60Hz +10dB, shelving type. Controls low end push
- ⑱ **Boost:** A post EQ gain stage using G.I.V.E. technology which adds 'growl' as it is turned up
- ⑲ **Tweeter:** Master volume control for the 50W tweeter amp
- ⑳ **Tweeter Hi-Cut:** Cuts frequencies above 10kHz, producing a more 'cone-like' (less harsh) sound from the tweeter
- ㉑ **Woofers:** Master volume control for the woofer (Main) amp
- ㉒ **Woofer X-Over:** Press this button to engage the electronic crossover for the woofer. This cuts frequencies above 5kHz
- ㉓ **Power Switch/Protect LED:** Turns the amplifier on or off. Should a problem occur during operation press this switch out first. The power LED should green at this point or flashing orange if a fault is present. The LED flashes at turn on for five seconds during power up. The LED turns blue when the amp is ready to play. Should the amp experience a fault (over heat, over current) the amp will mute and this LED will flash orange until the condition is corrected. This LED turns green when the power switch is turned off. When using two or more 2001RBs in a master/slave configuration, the power LED on the slave amps will be orange. The LEDs will turn blue when the master amp is turned on.

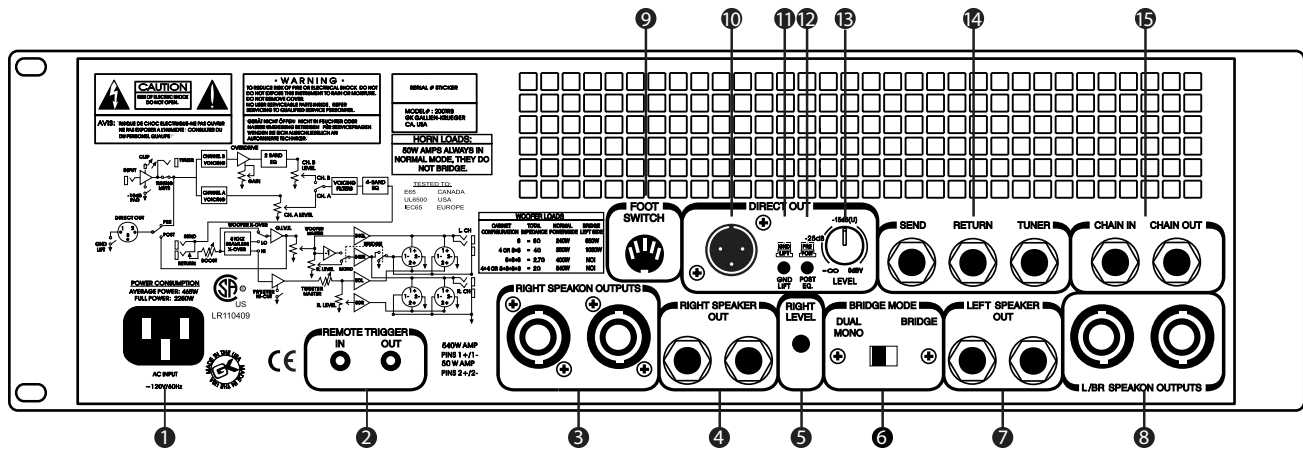

## Rear Panel Features

- 1 **AC Receptacle:** The power cord is detachable and plugs in here.
- 2 **Remote Trigger:** This feature is used when using multiple 2001RBs as 'master' and 'slave' units. It allows you to turn on all amplifiers at the same time, when the 'master' unit is powered on. Accepts the +12VDC signal from the 'master' 2001RB's Trigger Out jack to activate or turn on, the 'slave' 2001RBs when in standby mode. Provides +12VDC as a trigger output to remotely turn on a 'slave' 2001RB
- 3 **Right 'Speakon' Outputs:** Enables biamp operation by connecting a GK biamp compatible cabinet with a 4 conductor Speakon cable. This connects the 50W amplifier allowing the Tweeter control on the front panel to control the signal going to the horn. See Biamp and Normal Operation on page 9 for more information.
- 4 **Right Speaker Out:** 540W power amp output for Full-Range operation only. They deliver 540 watts into 2 Ohms or 360 watts into 4 Ohms. Lower impedances should not be used.
- 5 **Right Level:** This adjusts the output level of the right channel only in dual-mono mode.
- 6 **Bridge Mode:** This allows one to switch from Dual/Mono to Bridge mode.
- 7 **Left Speaker Out:** 540W power amp output for Full-Range operation only. They deliver 540 watts into 2 Ohms or 360 watts into 4 Ohms. Lower impedances should not be used.
- 8 **Left/Bridged Speakon Outputs:** Enables biamp operation by connecting a GK bi-ampable cabinet with a 4 conductor Speakon cable. This connects the 50W amplifier allowing the tweeter control on the front panel to control the signal going to the horn. See Biamp and Normal Operation on page 9 for more information. These Speakon outputs also enable bridged mode operation. When in bridged mode, the 2001RB will be in a simultaneous bridged/biamp mode, since the 50W horn amplifiers are always active (in the clean channel only) unless you choose to use the 'horn mute' feature, via the RFB-III footswitch.

NEVER CONNECT ANYTHING TO THE RIGHT CHANNEL OUTPUTS WHEN IN BRIDGED MODE! DO NOT USE BRIDGE MODE CABLES WITH THIS AMPLIFIER. THIS COULD CAUSE A SERIOUS MALFUNCTION AND/OR DAMAGE TO THE AMPLIFIER!

- 9 **Footswitch:** Provides a means to hook up the RFB-III, three button footswitch to your amplifier, with a standard 5 pin DIN (MIDI) cable. The RFB-III allows remote Channel Switching (Level A or Level B), Horn Mute (when in the clean channel) and Tuning Mute
- 10 **Direct Out:** Use this balanced adjustable (with the level control #13) output to connect to a P.A. system.
- 11 **Gnd/Lift Switch:** This switch disconnects the ground on the balanced, XLR output to eliminate hum and buzz when connecting to equipment that is running on a different ground system.
- 12 **Direct Out/Pre/Post EQ:** Selects whether the direct out signal is before or after the E.Q.
- 13 **Level:** This is the volume control for the direct out
- 14 **Send, Return & Tuner:** Line level output that is post EQ and pre Boost. Used when sending a full range mono signal to an external device (effects, processors, etc.) Accepts line level return from external effects that are connected in a series loop. Output comes directly off the input stage and can be patched to a tuner with a shielded patch cord. This output is unaffected by the tuning mute feature.
- 15 **Chain In & Chain Out:** This 'daisy chain' feature is used when multiple 2001RBs are used as 'master' and 'slave' units. Both jacks are stereo, where the tip is the woofer output and the ring is the horn output. When the master amp's Chain out signal is input to the slave amp's Chain in, the slave amp's preamp/tone control section is bypassed completely, and will serve as a straight power amp only. This output is used to daisy chain or connect other slave amps to the master amp. The signal going into the slave amp's Chain in is the same signal coming out of the Chain out. This eliminates the need for special Y adaptor when using the Daisy Chain feature, the stereo cable cord as short as possible to reduce hum/noise.

## Tech Talk

The 2001RB is a flexible, state of the art bass amplifier, designed to deliver maximum performance, and be simple to operate. This is accomplished through a few, very important features:

**Extremely high current power supply and power amp circuitry allows you to create the tones you've always imagined having in a bass amp.**

**Bi-Amp sound, two power amps, 540 Watts for the woofer (1080W bridged) and 50 Watts for the horn.**

**Electronic crossover, seamless two-way sound. Four, Bass specific bands of active equalization for precise tone control.**

**Three voicing filters for shaping and customizing your sound.**

**Balanced direct output with level control eliminates need for a direct box.**

**Continuously variable fan cooling.**

**Designed and Built in the U.S. for years of reliability and quality service.**

**High Current Output & Bass Response:** When a power amplifier is pushing several speaker cones, and a high power transient like a string slap comes along, the amp has to tap into a large power reserve to maintain cone control. It's kind of like grabbing a swing at the bottom of it's travel and trying to push it the other way - it could knock you over. If the amplifier doesn't have this ability, the sound is unresponsive and less out front. The amp loses it's punch and feel at higher playing levels. Instead of responding to your every command, the amplifier simply cuts those transients off, leaving you with the feeling that something is missing in your sound. Since most amplifiers have limited output current capacity, they need 'current limiting circuits' to protect against self destruction. High power transients trigger these circuits, which rob the amplifier of it's ability to control speaker cones. This creates a mushy, unresponsive feel to your sound. The 2001RB has extremely high current capacity, so it doesn't need current limiting circuits for overload protection. There is nothing in the 2001RB power amp to come between you and your sound except faithful, raw power.

**Biamp Sound:** Bass players have always liked the growl they get from slight overdrive. In GK amps this comes partly from the boost circuits and partly from the power amp. The problem is that growl, sounds great through woofers, and horrible through horns. In the typical full range system with a passive crossover, there is no way to get growl and keep the definition that the horn provides. The horn always has to be turned down. In a biamp system like the 2001RB, the woofer and the horn, each have their own power amp, allowing us to get growl in the woofer only, while keeping the horn sound crystal clear. Now you can overdrive the woofer as much as you want, and leave the horn all the way up, keeping the definition it brings to your sound. Running the 2001RB in biamp mode through a GK-RBH or NEO cabinet, for the first time allows full access to the benefits of biamp sound. This is the reason the 2001RB is a biamp, and it is the reason you will be able to explore an entirely new territory of bass sound.

**Electronic Crossover:** Biamp systems allow the crossover to be electronic and therefore, have much higher quality and control of your sound than passive crossovers. A crossover separates the sound into two parts (high and low frequency). The highs are sent to the horn or high frequency cabinet and the lows are sent to the woofer. In an ideal system, adding the highs and the lows back together would recover the original signal. Most passive bass systems have very poor crossovers, resulting in severe signal corruption. When these signals are added back together (as in your ear), they have very little in common with the original signal. The 2001RB uses a constant voltage crossover which results in very little signal corruption. In fact, when the high and low signals are added back together, the result is extremely close to the original. This makes a two way system sound more seamless, and less artificial. We have also included a Tweeter Hi-Cut switch in the crossover, which rolls the tweeter off above 10kHz giving it a less glassy, more cone like sound.

**Tech Talk (continued)**

**Equalization:** The sound you want is in your head, but you just can't get it. You think it's you, your bass or maybe your amp. Yes, your amp. Standard tone controls and graphic equalizers don't get it. Sure, they give you plenty of variation, but they don't provide what the instrument really needs. The fact is, graphic equalizers are intended for room equalization, and are only put in bass amps because it's a no brainer for the designer. The equalization in Gallien-Krueger amplifiers reflects 30 years of continuous development and refinement. The GK equalizer is unique to the industry, it's not just a normal four band equalizer, each section is a special circuit optimized to perform a bass specific job in its range of operation. These sections are wired in series, so they add to one another creating a tremendously flexible equalizer, that doesn't sound weird at any setting. You actually might even get to hear that sound in your head.

**Voicing Filters:** Voicing filters are used to completely re voice the amplifier. In the case of the Contour and String Bass controls, the effect is dramatic. The Contour control tunes between two different shaping circuits, with greatly different response. With the control all the way up, the low end is slightly boosted, the mids are dropped and the high end is pushed up. This is a response contour not available with a normal equalizer, and is only found in GK amplifiers. The way a Bass amp deals with the instrument low string is a critical part of it's sound. In fact, a five string instrument requires an entirely different low end response than a four string instrument. No equalizer can make the necessary adjustments to accommodate both, however the String Bass button on the 2001RB does just that. When it is out, the 2001RB is voiced like the 800RB. Push it in and the 2001RB is voiced for five string instruments. For some playing styles you may want it in, even with a four string instrument. At least now, you have a choice!

**G.I.V.E. Technology:** As in all GK preamps, the 2001RB preamp incorporates what we call G.I.V.E (Gate Induced Valve Effect) technology. We use field effect devices with the gate biased in a way that emphasizes the optimum harmonic content of the signal. Working in concert with our unique Four Band Active Equalizer, and three stage Voicing Filter Section, G.I.V.E. technology produces a consistently pleasing bass tone.

**Cool Running = Reliability:** The 2001RB uses a dual rail power supply that generates about half the heat of conventional amplifiers. Low output signals run off a low voltage supply, and high level signals run off a high voltage supply. This keeps the amp running a lot cooler and makes it much more reliable. To cool the amp when it's being driven hard, we've designed a temperature sensitive fan cooling system. When the amp is under a light load, the fan is off or running at a low speed, reducing fan noise. As the amp works harder, the fan speed increases to keep everything cool.

**Smart Protection Circuitry:** The 2001RB's protection circuitry constantly monitors for unsafe operating conditions such as short circuits, miswired speaker cables, blown speakers, improper ventilation and incorrect speaker configurations. In addition, protection is provided during power up/down. If the 2001RB senses any unsafe operating conditions, the output signal is immediately muted and the power light changes from Blue to flashing orange. The amplifier will remain muted until the fault is removed. If the protection circuit activates while playing, turn the amplifier off and check the amplifier speaker output connections. Be sure that you are not exceeding the maximum recommend load described in this manual. Also, make sure that you have connected the amplifier to your speakers as described in Biamp and Normal Operation on page 9. If the problem persists, contact GK directly for advice.

**Low Noise Operation:** The 2001RB uses a high gain, high headroom, low noise input stage. It has such a large dynamic range (60v p-p) that very few instruments can overdrive it. Even most basses with active electronics do not need the input attenuator to be set. The benefit to you is less hiss from your horn, and over all, much less noise.

**In Closing:** You should now have a thorough understanding of how your new 2001RB amplifier works and what advantages it can offer you in getting "your" sound. We thank you for reading the Owner's Manual and wish you the best of times! Please send us your comments via [www.gallien-krueger.com](http://www.gallien-krueger.com) or email us at [sales@gallien.com](mailto:sales@gallien.com).

## 2001RB Block Diagram

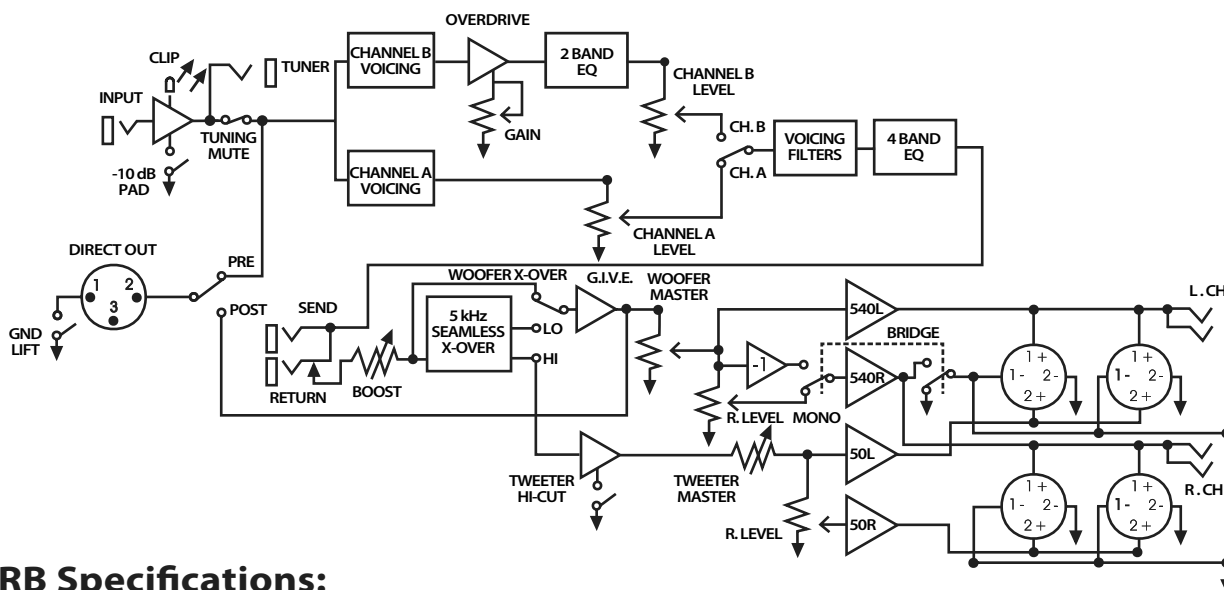

Specifications

### 2001RB Specifications:

#### Output Power

Woofer Amplifier: 2 x 540W @ 2 Ohms  
 2 x 360W @ 4 Ohms  
 2 x 240W @ 8 Ohms  
 1080W bridged @4 Ohms  
 650W bridged @8 Ohms  
 Horn Amplifier: 50W @ 4 Ohms

#### Input Section

Maximum Input Level: 0.6V Rms  
 With -10dB pad 1.6V Rms  
 Input Impedance: 1M Ohm  
 Send output impedance: 220 Ohms  
 Return input impedance: 50k Ohms  
 Tuner Output Impedance: 10k Ohm  
 Direct Output Impedance: 500 Ohms

#### Equalizer

Bass: +10db @ 60Hz  
 Lo-Mid: +6db/-10db @ 250Hz  
 Hi-Mid: +6db/-10db @ 1kHz  
 Treble: +14db @ 7kHz

#### Voicing Filters

String Bass Button: +11db@20Hz  
 Contour: +2db@50Hz / -10db@500Hz / +3db@7kHz  
 Presence: +9db@10kHz

Crossover: Triple pole constant voltage crossover at 5kHz

Noise: -90db referenced to 500W, 'A' weighted

Cooling: Continuously Variable-Speed Fan

Amplifier Protection: Full short circuit, thermal & RF protection. Stable into reactive and mismatched loads. Five second muted warm up.

Dimensions (HxWxD): 5.25" x 19" x 12"  
 (3Rack Spaces)

Weight: 40 lbs

Power Requirements:

U.S.A./Canada 120V/60Hz  
 (full power) 2250W  
 (average power) 595W

Europe 230V/50Hz  
 (full power) 2250W  
 (average power) 595W

Japan 100V/50Hz  
 (full power) 2250 W  
 (average power) 595W

LR110409



This device has been tested and found to comply with: CAN/CSA 60065-03 Safety Requirements. UL std. No. 60065-2007 Safety Requirements.

**GK GALLIEN-KRUEGER**

2001RB Owner's Manual  
 Part #160-0290-B  
 Printed in the U.S.A.